



■ Features

- Wide input range 180 ~ 528VAC
- Constant Voltage + Constant Current mode output
- Metal housing with Class I design
- Built-in active PFC function
- IP67 / IP65 rating for indoor or outdoor installations
- Function options: output adjustable via potentiometer; 3 in 1 dimming (dim-to-off) ; Timer dimming
- Typical lifetime>50000 hours
- 5 years warranty

■ Applications

- LED street lighting
- LED high-bay lighting
- Parking space lighting
- LED fishing lamp
- LED greenhouse lighting
- Type “HL” for use in Class I , Division 2 hazardous (Classified) location.

■ Description

HVG-150 series is a 150W AC/DC LED power supply featuring the dual mode constant voltage and constant current output. HVG-150 operates from 180~528VAC and offers models with different rated voltage ranging between 12V and 54V. Thanks to the high efficiency up to 91.5%, with the fanless design, the series is able to operate from -40°C through as high as +85°C case temperature under free air convection. The design of metal housing and IP67/IP65 ingress protection level allows this series to fit both indoor and outdoor applications. HVG-150 is equipped with various function options, such as dimming methodologies, so as to provide the optimal design flexibility for LED lighting system.

■ Model Encoding

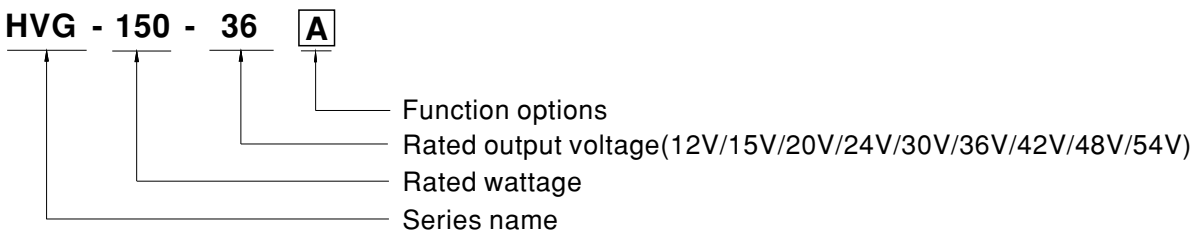

| Type | IP Level | Function | Note |
|------|----------|--|------------|
| A | IP65 | Io and Vo adjustable through built-in potentiometer. | In Stock |
| B | IP67 | 3 in 1 dimming function (0~10Vdc, 10V PWM signal and resistance) | In Stock |
| AB | IP65 | Io and Vo adjustable through built-in potentiometer & 3 in 1 dimming function (0~10Vdc, 10V PWM signal and resistance) | In Stock |
| D | IP67 | Timer dimming function, contact MEAN WELL for details(safety pending). | By request |



SPECIFICATION

| MODEL | HVG-150-12 | HVG-150-15 | HVG-150-20 | HVG-150-24 | HVG-150-30 | HVG-150-36 | HVG-150-42 | HVG-150-48 | HVG-150-54 | | |
|---|---|---|------------|-------------|--------------|------------|--------------|--------------|--------------|--------------|--|
| OUTPUT | DC VOLTAGE | 12V | 15V | 20V | 24V | 30V | 36V | 42V | 48V | 54V | |
| | CONSTANT CURRENT REGION <small>Note.4</small> | 7.2~12V | 8.25~15V | 11~20V | 13.2~24V | 16.5~30V | 19.8~36V | 23.1~42V | 26.4~48V | 29.7~54V | |
| | RATED CURRENT | 10A | 10A | 7.5A | 6.25A | 5A | 4.17A | 3.58A | 3.13A | 2.78A | |
| | RATED POWER | 120W | 150W | 150W | 150W | 150W | 150.12W | 150.36W | 150.24W | 150.12W | |
| | RIPPLE & NOISE (max.) <small>Note.2</small> | 150mVp-p | 150mVp-p | 150mVp-p | 150mVp-p | 200mVp-p | 200mVp-p | 200mVp-p | 200mVp-p | 200mVp-p | |
| | VOLTAGE ADJ. RANGE | Adjustable for A/AB-Type only (via the built-in potentiometer) | | | | | | | | | |
| | | 10.8 ~ 13.5V | 13.5 ~ 17V | 17 ~ 22V | 22 ~ 27V | 27 ~ 33V | 33 ~ 40V | 38 ~ 46V | 43 ~ 53V | 49 ~ 58V | |
| | CURRENT ADJ. RANGE | Adjustable for A/AB-Type only (via the built-in potentiometer) | | | | | | | | | |
| | | 6 ~ 10A | 5.5 ~ 10A | 4.13 ~ 7.5A | 3.44 ~ 6.25A | 2.75 ~ 5A | 2.29 ~ 4.17A | 1.97 ~ 3.58A | 1.72 ~ 3.13A | 1.53 ~ 2.78A | |
| | VOLTAGE TOLERANCE <small>Note.3</small> | ±2.5% | ±2.0% | ±1.0% | ±1.0% | ±1.0% | ±1.0% | ±1.0% | ±1.0% | ±1.0% | |
| LINE REGULATION | ±0.5% | ±0.5% | ±0.5% | ±0.5% | ±0.5% | ±0.5% | ±0.5% | ±0.5% | ±0.5% | | |
| LOAD REGULATION | ±2.0% | ±1.5% | ±1.0% | ±0.5% | ±0.5% | ±0.5% | ±0.5% | ±0.5% | ±0.5% | | |
| SETUP, RISE TIME <small>Note.6</small> | 500ms, 80ms /230VAC, 347VAC, 480VAC | | | | | | | | | | |
| HOLD UP TIME (Typ.) | 18ms/347VAC, 480VAC | | | | | | | | | | |
| INPUT | VOLTAGE RANGE <small>Note.5</small> | 180 ~ 528VAC 254VDC ~ 747VDC (Please refer to "STATIC CHARACTERISTIC" section) | | | | | | | | | |
| | FREQUENCY RANGE | 47 ~ 63Hz | | | | | | | | | |
| | POWER FACTOR (Typ.) | PF ≥ 0.98/230VAC, PF ≥ 0.97/277VAC, PF ≥ 0.95/347VAC, PF ≥ 0.93/480VAC @full load (Please refer to "POWER FACTOR (PF) CHARACTERISTIC" section) | | | | | | | | | |
| | TOTAL HARMONIC DISTORTION | THD < 20% (@ load ≥ 50%/230VAC, 277VAC, 347VAC @ load ≥ 60% only for 12V model); @ load ≥ 75%/480VAC (Please refer to "TOTAL HARMONIC DISTORTION (THD)" section) | | | | | | | | | |
| | EFFICIENCY (Typ.) | 87% | 89% | 90.5% | 91% | 91% | 91% | 91% | 91.5% | 91.5% | |
| | AC CURRENT (Typ.) | 347VAC | 0.45A | 0.5A | | | | | | | |
| | | 480VAC | 0.35A | 0.38A | | | | | | | |
| | INRUSH CURRENT (Typ.) | COLD START 35A(twidth=790μs measured at 50% I _{peak}) at 480VAC; Per NEMA 410 | | | | | | | | | |
| MAX. No. of PSUs on 16A CIRCUIT BREAKER | 4 units (circuit breaker of type B) / 6 units (circuit breaker of type C) at 480VAC | | | | | | | | | | |
| LEAKAGE CURRENT | <0.75mA / 480VAC | | | | | | | | | | |
| PROTECTION | OVER CURRENT | 95 ~ 108% Constant current limiting, recovers automatically after fault condition is removed | | | | | | | | | |
| | SHORT CIRCUIT | Constant current limiting, recovers automatically after fault condition is removed | | | | | | | | | |
| | OVER VOLTAGE | 14.4 ~ 16.8V | 18 ~ 21V | 23 ~ 27V | 28 ~ 34V | 34 ~ 38V | 41 ~ 46V | 47 ~ 53V | 54 ~ 60V | 59 ~ 65V | |
| | | Shut down o/p voltage with auto-recovery or re-power on to recovery | | | | | | | | | |
| OVER TEMPERATURE | Shut down o/p voltage, recovers automatically after temperature goes down | | | | | | | | | | |
| ENVIRONMENT | WORKING TEMP. | T _{case} =-40 ~ +85°C (-40 ~ +75°C for 12V model, -40 ~ +80°C for 15V model)(Please refer to "OUTPUT LOAD vs TEMPERATURE" section) | | | | | | | | | |
| | MAX. CASE TEMP. | T _{case} =+85°C (+75°C for 12V model, +80°C for 15V model) | | | | | | | | | |
| | WORKING HUMIDITY | 20 ~ 95% RH non-condensing | | | | | | | | | |
| | STORAGE TEMP., HUMIDITY | -40 ~ +80°C, 10 ~ 95% RH | | | | | | | | | |
| | TEMP. COEFFICIENT | ±0.03%/°C (0 ~ 60°C) | | | | | | | | | |
| VIBRATION | 10 ~ 500Hz, 5G 12min./1cycle, period for 72min. each along X, Y, Z axes | | | | | | | | | | |
| SAFETY & EMC | SAFETY STANDARDS <small>Note.7</small> | UL8750(type"HL"), CSA C22.2 No. 250.0-08, EAC TP TC 004, IP65 or IP67 approved | | | | | | | | | |
| | WITHSTAND VOLTAGE | I/P-O/P:3.75KVAC I/P-FG:2KVAC O/P-FG:1.5KVAC | | | | | | | | | |
| | ISOLATION RESISTANCE | I/P-O/P, I/P-FG, O/P-FG:100M Ohms / 500VDC / 25°C / 70% RH | | | | | | | | | |
| | EMC EMISSION | Compliance to EN55015, EN61000-3-2 Class C (@ load ≥ 55% load, @ load ≥ 60% only for 12V model); EN61000-3-3, FCC Part 15 Subpart, EAC TP TC 020 | | | | | | | | | |
| | EMC IMMUNITY | Compliance to EN61000-4-2, 3, 4, 5, 6, 8, 11, EN61547, light industry level (surge immunity Line-Earth 4KV, Line-Line 2KV), EAC TP TC 020 | | | | | | | | | |
| OTHERS | MTBF | 158.6K hrs min. MIL-HDBK-217F (25°C) | | | | | | | | | |
| | DIMENSION | 245*68*38.8mm (L*W*H) | | | | | | | | | |
| | PACKING | 1.24Kg; 12pcs/15.9Kg/0.78CUFT | | | | | | | | | |
| NOTE | <ol style="list-style-type: none"> All parameters NOT specially mentioned are measured at 347VAC input, rated load and 25°C of ambient temperature. Ripple & noise are measured at 20MHz of bandwidth by using a 12" twisted pair-wire terminated with a 0.1uf & 47uf parallel capacitor. Tolerance : includes set up tolerance, line regulation and load regulation. Please refer to "DRIVING METHODS OF LED MODULE". De-rating may be needed under low input voltages. Please refer to "STATIC CHARACTERISTIC" sections for details. Length of set up time is measured at first cold start. Turning ON/OFF the power supply may lead to increase of the set up time. The driver is considered as a component that will be operated in combination with final equipment. Since EMC performance will be affected by the complete installation, the final equipment manufacturers must re-qualify EMC Directive on the complete installation again. This series meets the typical life expectancy of >50,000 hours of operation when T_{case}, particularly (T_c) point (or TMP, per DLC), is about 75°C or less. Please refer to the warranty statement on MEAN WELL's website at http://www.meanwell.com. The ambient temperature derating of 3.5°C/1000m with fanless models and of 5°C/1000m with fan models for operating altitude higher than 2000m(6500ft). For any application note and IP water proof function installation caution, please refer our user manual before using. https://www.meanwell.com/Upload/PDF/LED_EN.pdf | | | | | | | | | | |

Block Diagram

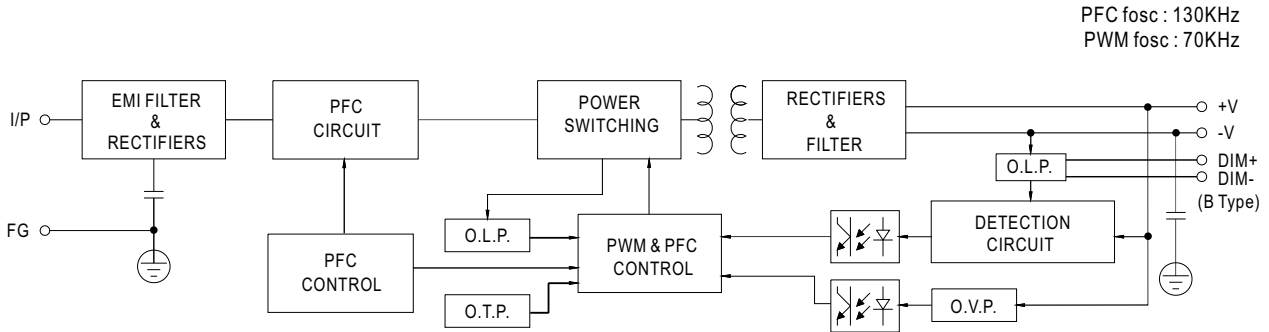

DRIVING METHODS OF LED MODULE

※ This series is able to work in either Constant Current mode (a direct drive way) or Constant Voltage mode (usually through additional DC/DC driver) to drive the LEDs.

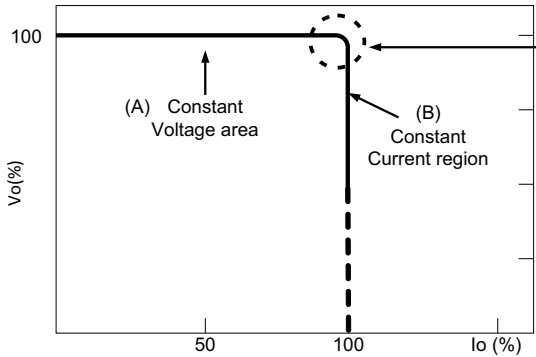

Typical output current normalized by rated current (%)

In the constant current region, the highest voltage at the output of the driver depends on the configuration of the end systems.

Should there be any compatibility issues, please contact MEAN WELL.

DIMMING OPERATION



※ 3 in 1 dimming function (for B/AB-Type)

- Output constant current level can be adjusted by applying one of the three methodologies between DIM+ and DIM-: 0 ~ 10VDC, or 10V PWM signal or resistance.
- Direct connecting to LEDs is suggested. It is not suitable to be used with additional drivers.
- Dimming source current from power supply: 100 μ A (typ.)

◎ Applying additive 0 ~ 10VDC

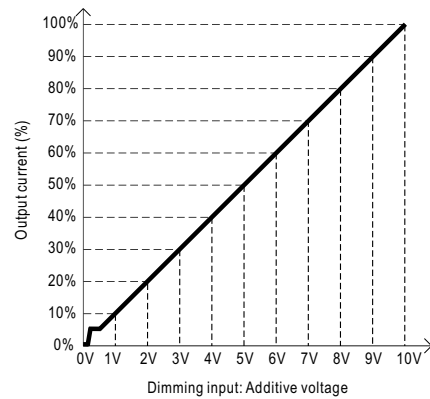
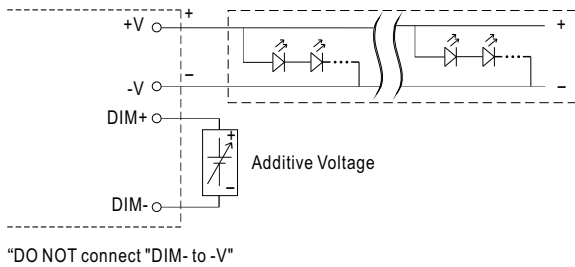

◎ Applying additive 10V PWM signal (frequency range 100Hz ~ 3KHz):

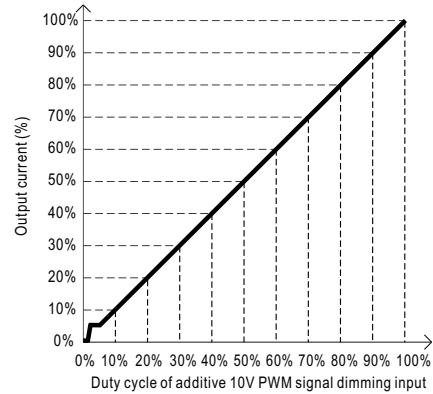
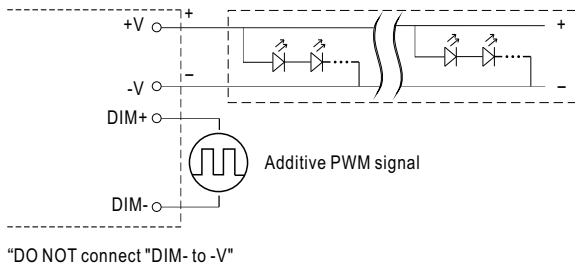

◎ Applying additive resistance:

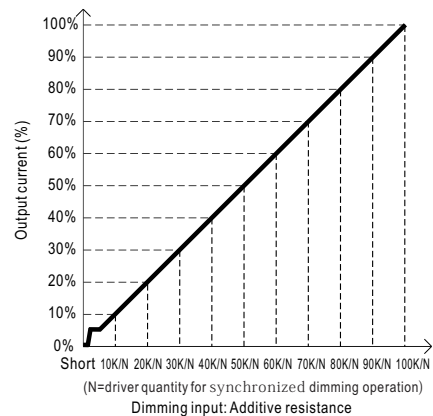
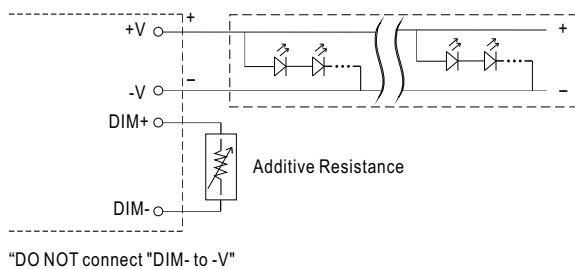

Note : 1. Min. dimming level is about 6% and the output current is not defined when $0\% < I_{out} < 6\%$.

2. The output current could drop down to 0% when dimming input is about $0k\Omega$ or 0Vdc, or 10V PWM signal with 0% duty cycle.

OUTPUT LOAD vs TEMPERATURE(Notes.9)

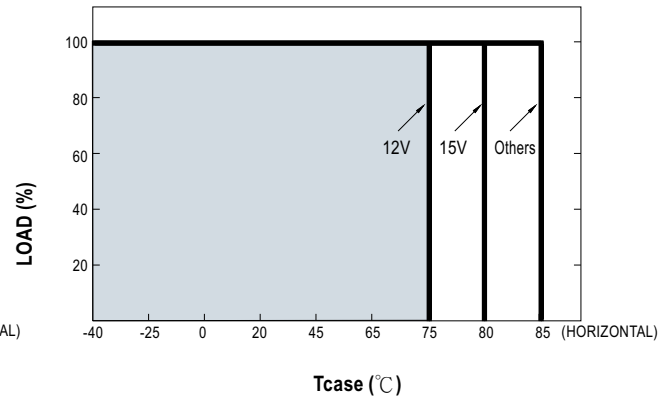
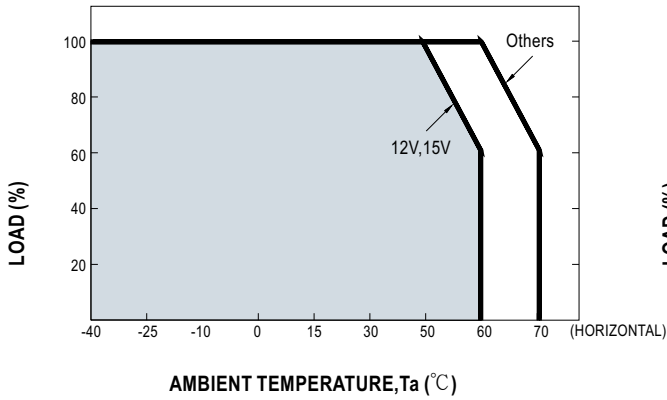

STATIC CHARACTERISTIC

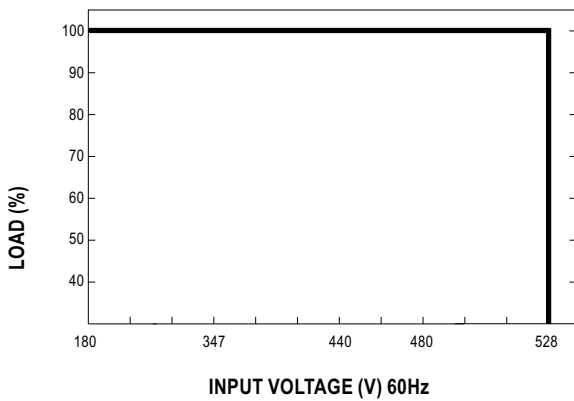

POWER FACTOR (PF) CHARACTERISTIC

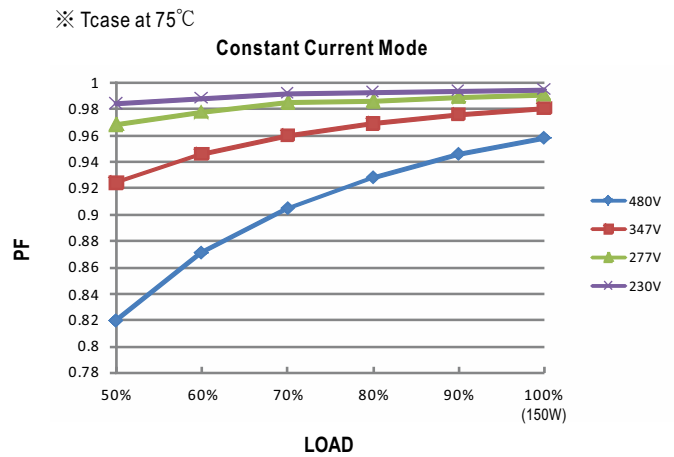

TOTAL HARMONIC DISTORTION (THD)

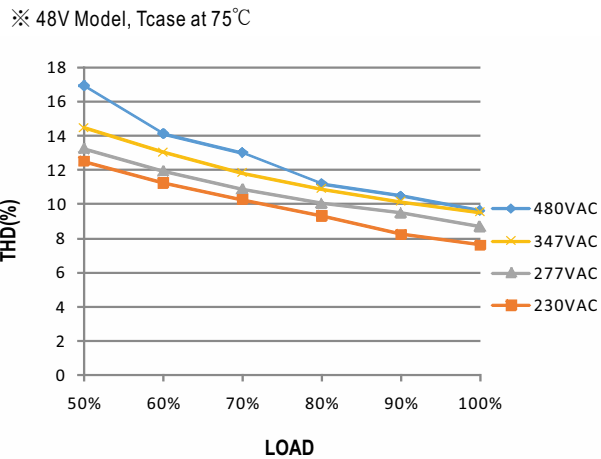

EFFICIENCY vs LOAD

HVG-150 series possess superior working efficiency that up to 91.5% can be reached in field applications.

※ 48V Model, Tcase at 75°C

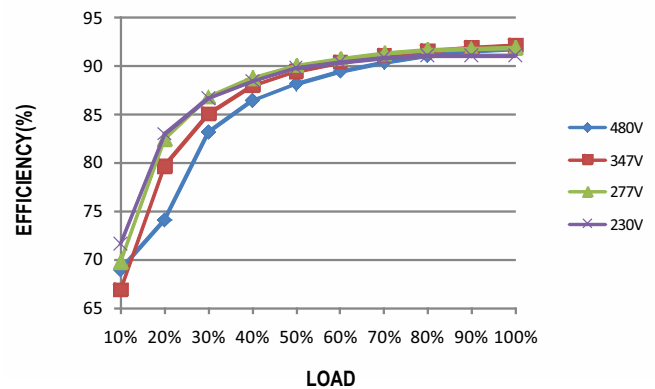

■ LIFE TIME

※ For HVG-150-12

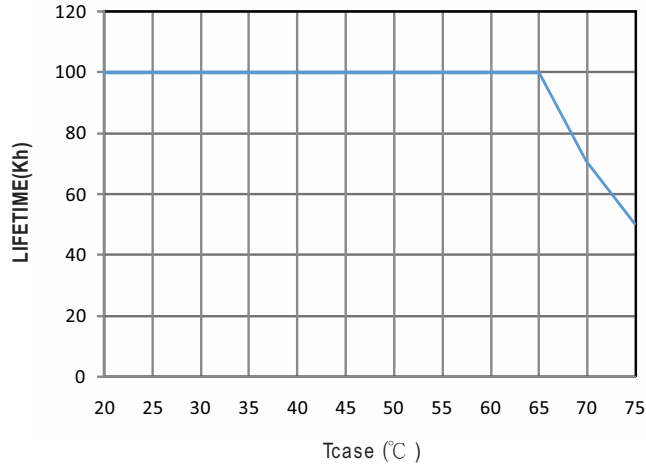

※ For HVG-150-15

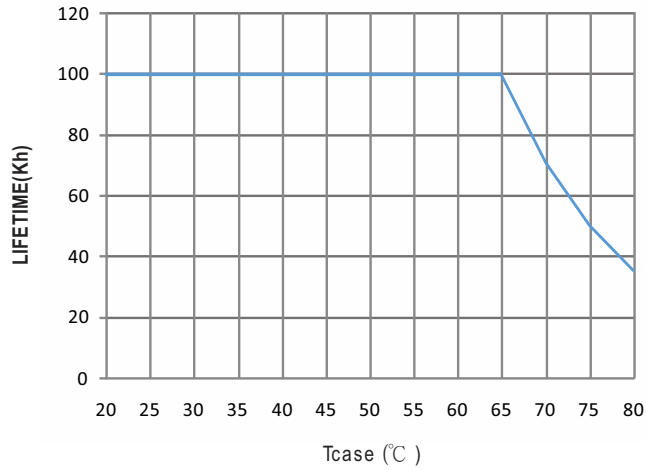

※ For others

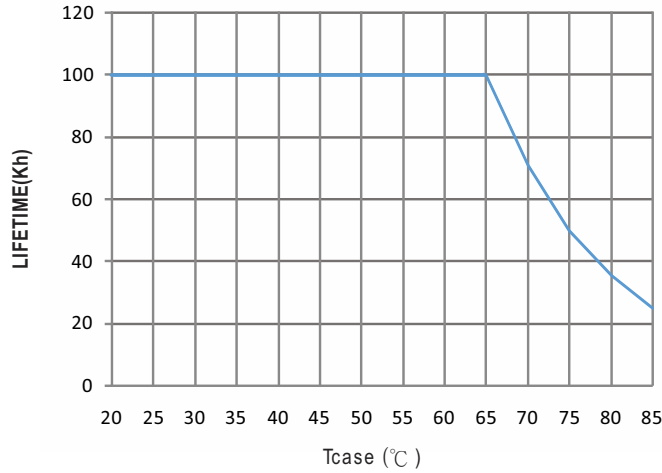

MECHANICAL SPECIFICATION

Case No. 994 Unit:mm

※ **A-Type**

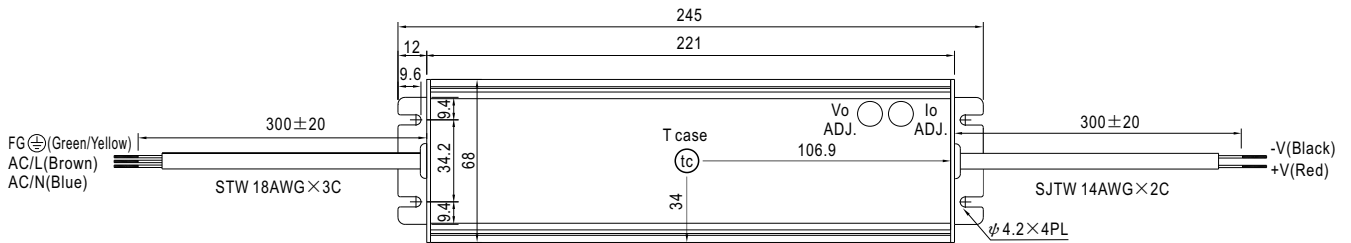

• (tc) : Max. Case Temperature

※ **B-Type**

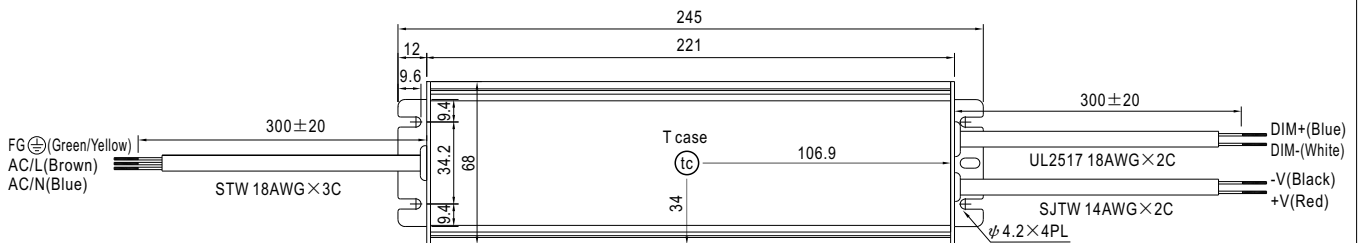

• (tc) : Max. Case Temperature

※ AB-Type

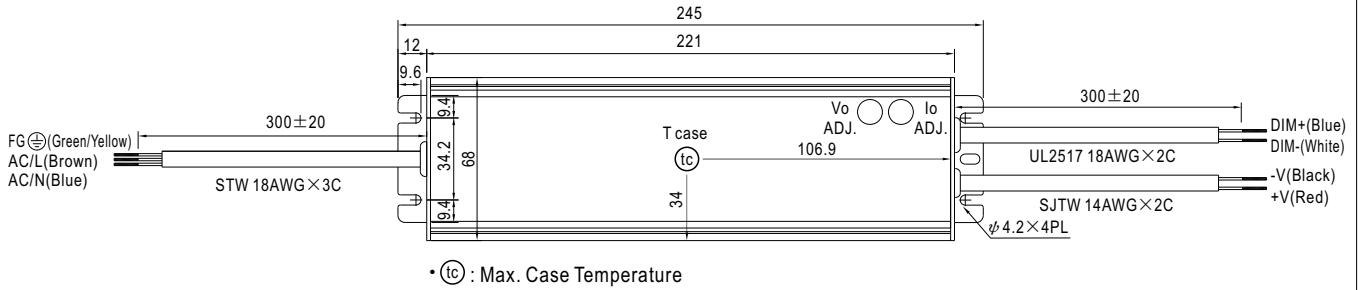

※ D-Type

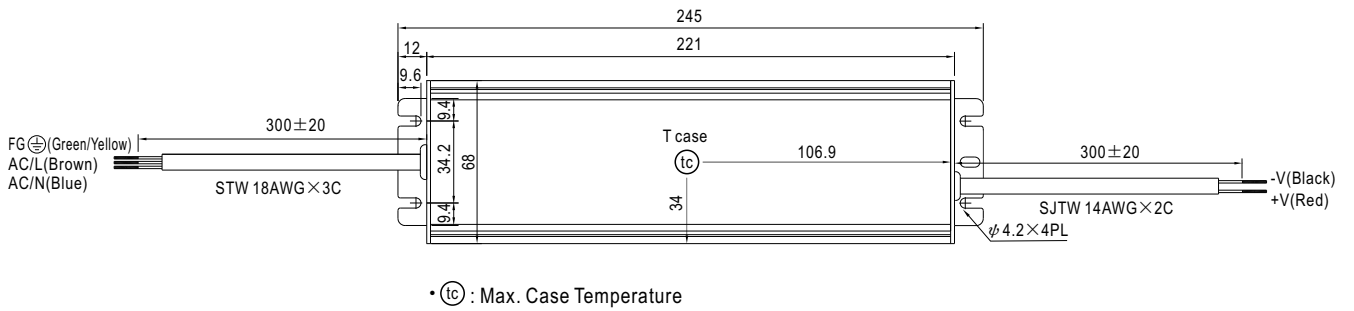

■ WATERPROOF CONNECTION

※ Waterproof connector

Waterproof connector can be assembled on the output cable of HVG-150 to operate in dry/wet/damp or outdoor environment.

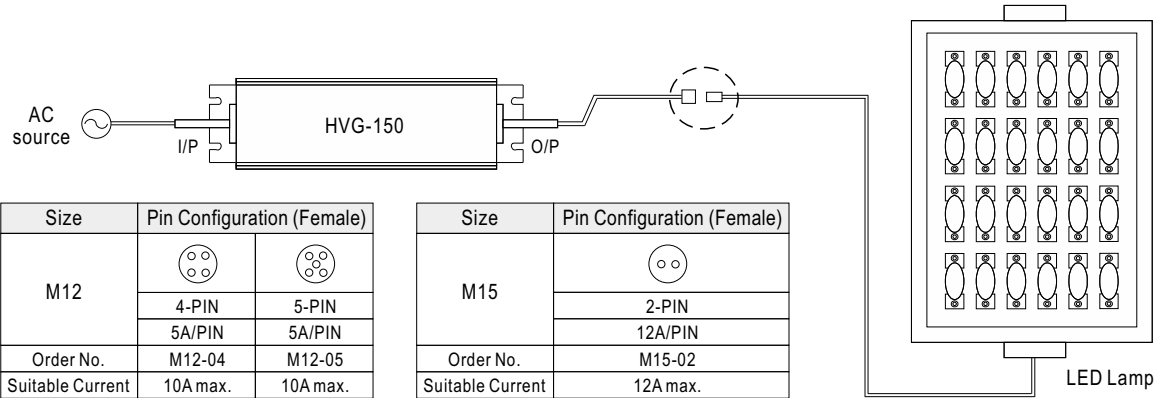

※ Cable Joiner

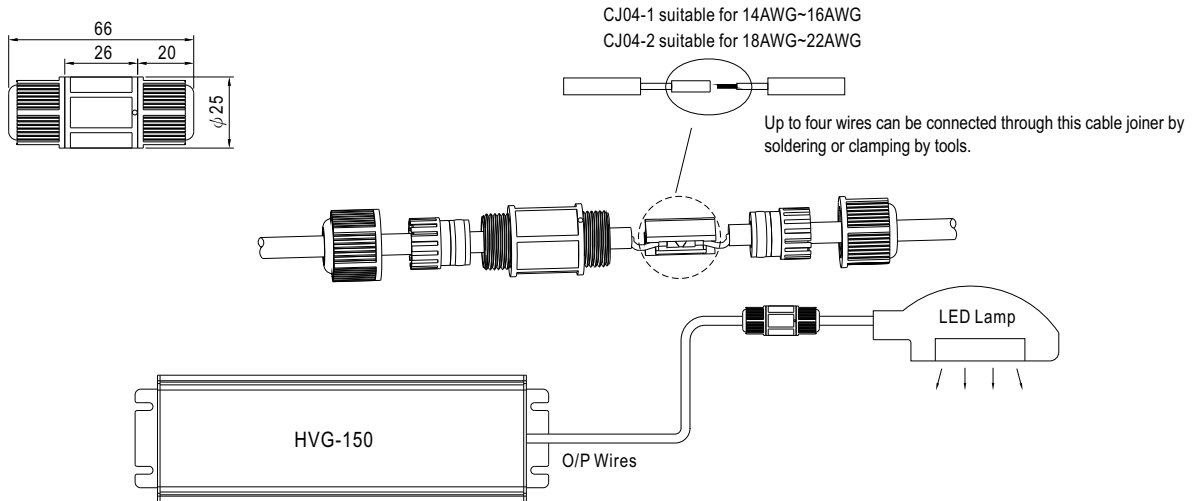

◎ CJ04 cable joiner can be purchased independently for user's own assembly.
MEAN WELL order No. : CJ04-1, CJ04-2.

※ Junction Box Option

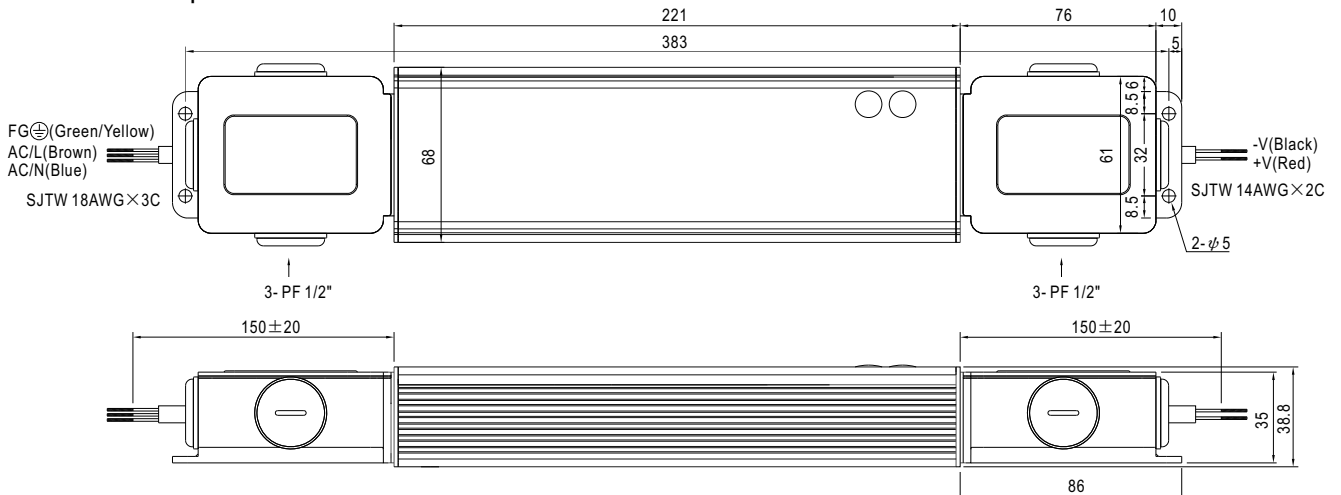

◎ Junction box option is available for A - Type. Please contact MEAW WELL for details.

■ INSTALLATION MANUAL

Please refer to : <http://www.meanwell.com/manual.html>