



D24VA100UNV-A

24 Volt/4.1A 96 Watt Class 2 LED Driver

- Universal input voltage 120 – 277 Vac
- 24V Constant Voltage Output
- 4.1A Constant Current



Performance

Input Voltage	120 ~ 277 Vac
Input Current Max	0.93 /120V 0.4/277V
Input Power Max	112W
Input Frequency	50 - 60 Hz
Power Factor	> 0.90
THD max	< 10 %
Max Output Power	96W
Constant Voltage Mode	
Output Voltage	24V
Output Current	4.15A Max
Constant Current Mode	
Output Voltage	15-23V
Output Current	4,150mA
Line Regulation	±5 %
Load Regulation	±5 %
Output Voltage Ripple	< 3%
Output Current Ripple	< 10%
Inrush Current	120V: 34A / 160uS
Peak / >50% Duration	277V: 89A / 160uS

Physical

Length	9.50 in (241.3 mm)
Width	1.70 in (43.2 mm)
Height	1.18 in (30.0 mm)
Mounting Length	8.89 in (225.8 mm)
Weight (lbs)	1.7
Lead Lengths	
Blk, Wht, Violet, Gray	8 in
Red(+), Black(-)	8 in

Lead-wires are 18 AWG 105°C /600V solid copper.

Protection

Over voltage, Overload and short circuit.

Safety:

UL 8750 & CSA 250.13-12

Environmental

EMI and RFI	Meets FCC part 15 (Class A) Non-Consumer Limits
Operating Temperature	-40°C to 60°C (-40°F to 140°F)
Storage Temperature	-40°C to 85°C (-40°F to 185°F)
tc	85°C (185°F) max
Protection Rating	UL Dry & Damp

Wiring Diagram:

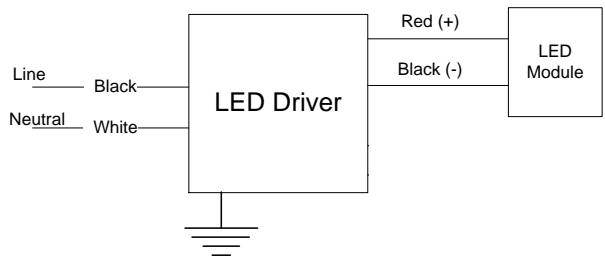

Application and operation performance specification information subject to change without notification.



Performance: Efficiency, THD, & Power Factor

Typical performance measurements are shown. The charts are to be used as a guideline and not for specification use.

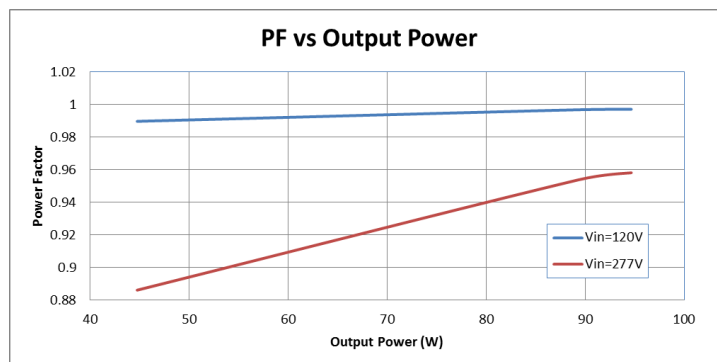
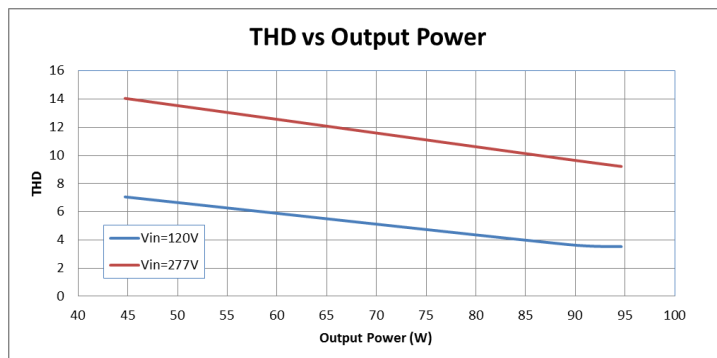
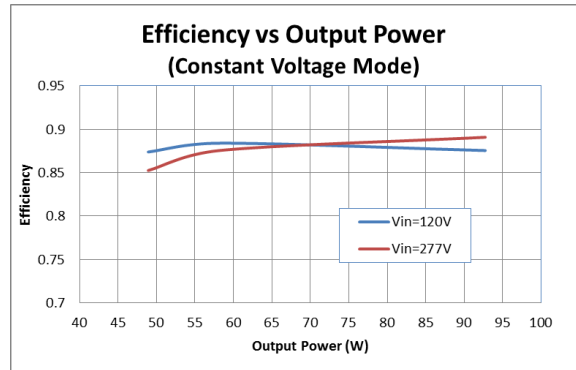
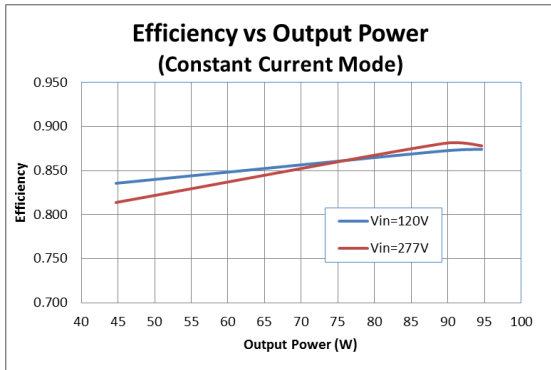

Output power based on maximum rated output current and varying load voltages.



Application and operation performance specification information subject to change without notification.



Life vs. Driver Tcase

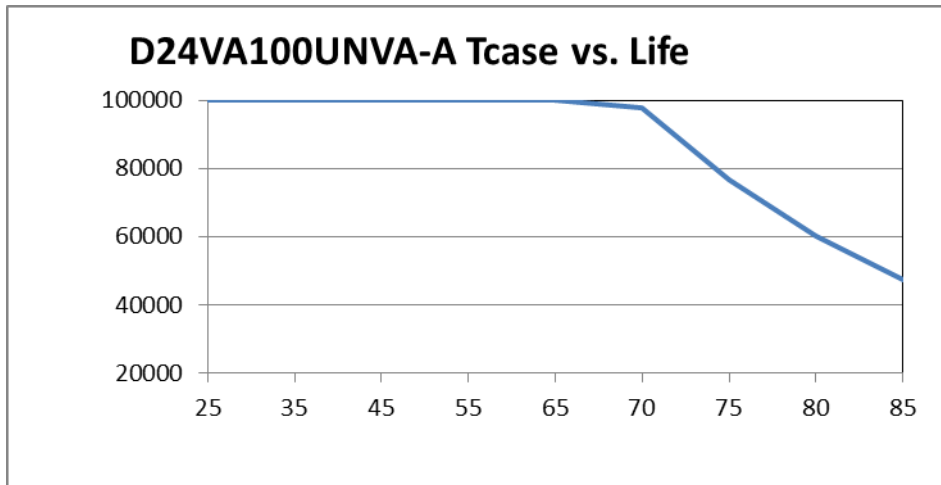

The Data curve provided predicts the LED Driver life based on the case temperature measured at the T_c location identified on the label or specification sheet. The Telecordia SR-332 standard is used to generate the prediction curves.

Dimensional Diagram

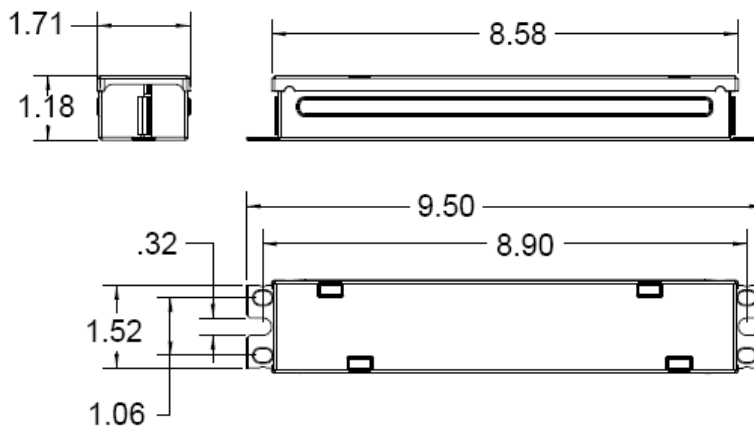

Application and operation performance specification information subject to change without notification.



Condition of Acceptability - When installed in the end use equipment, the following are among the considerations to be made:
1.The maximum working voltage present and dielectric voltage withstand test voltage applied between primary circuits and secondary output/enclosure for each models are tabulated below.

Working Voltage

471 Vrms, 764 Vpk

Hi-pot P-S and P-enclosure

4634 Vdc

- 2.The LED drivers have been considered ambient 55°C. If operated at a higher ambient temperature, it should be determined in end product.
- 3.The suitability of Electrical/Fire/Mechanical enclosure shall be determined in the end product.
- 4.The units are intended for factory installation only.
- 5.The LED drivers are intended for use in dry and/or damp locations. Other uses shall be considered in end product.
- 6.The drivers shall be installed in compliance with the enclosure, mounting, spacing, casualty, and segregation requirements of the end product application.
- 7.The suitability of input and output leads shall be determined in end product.
- 8.The drivers are provided with isolated class 2 output.
9. Dimmable models as shown on the product label are using a low voltage 0-10 V proprietary interface. This interface is a sink, since the interface operates from an external source of supply. The interface circuit has been evaluated for isolation from primary (input) circuits.
10. **As part of temperature testing, the case temperature at Tc was monitored. During the normal temperature test of the end product, the temperature at Tc is to be monitored. The absolute value at TC cannot exceed the Tref max value (°C), noted in product characteristics table.**

FCC Statement: This device complies with part 15 of the FCC Rules. Operation is subject to the following two conditions: (1) This device may not cause harmful interference, and (2) this device must accept any interference received, including interference that may cause undesired operation.

Warranty:

Universal Lighting Technologies warrants to the purchaser that each power supply will be free from defects in material or workmanship for a period of 5 years from the date of manufacture when properly installed per instructions and under normal operating conditions of use. Call 1-800-225-5278 for technical assistance.



Application and operation performance specification information subject to change without notification.